

pixl-latr

GETTING STARTED GUIDE

[FILM NOW] PIXL-LATR

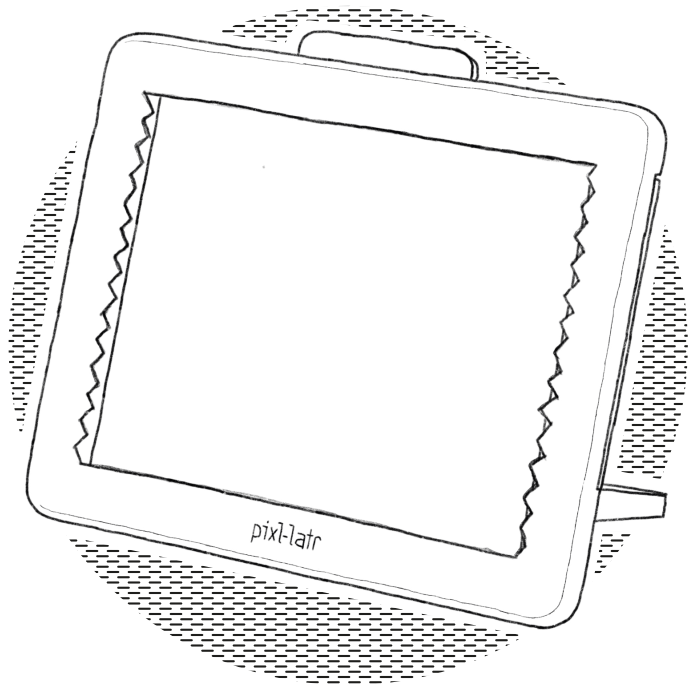

THANK YOU FOR PURCHASING

pixl-latr

pixl-latr is a tool designed to aid in the process of digitising negative and reversal film with a digital camera.

It has two primary functions; holding your film flat and diffusing a light source behind it.

pixl-latr
HAS 10 PARTS

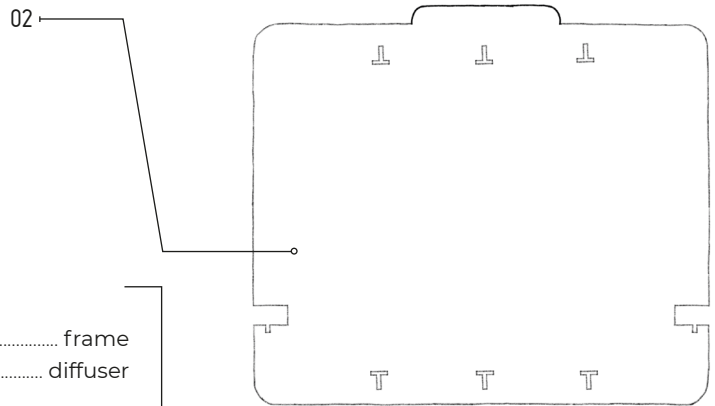
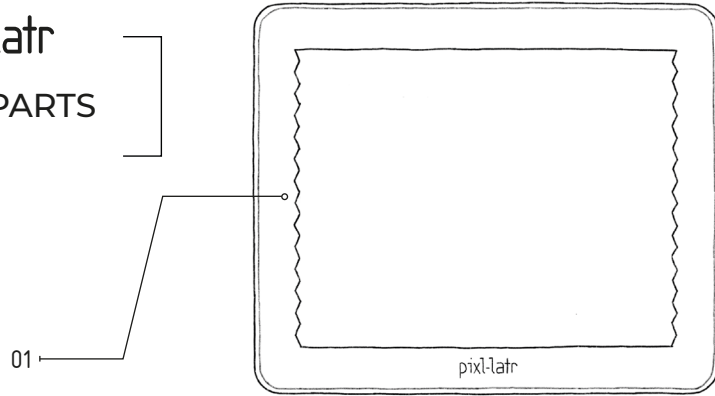

- 01 frame
- 02 diffuser

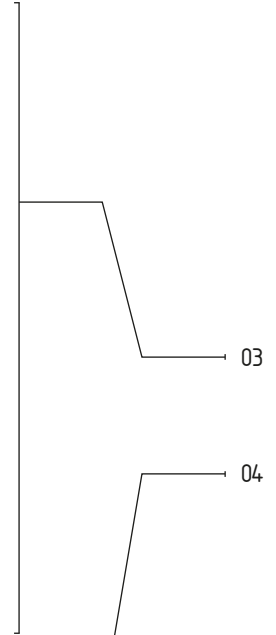
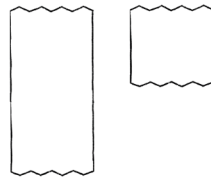
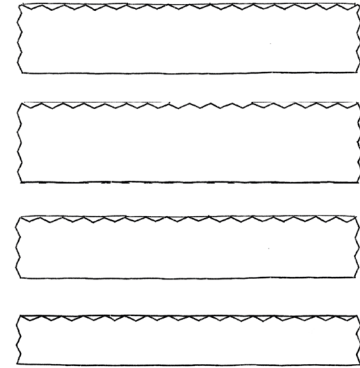

- 03 6 gates
- 04 2 legs

DIFFUSER

The diffuser has the simple job of diffusing the backlight. This enables pixl-latr to be used with a wide variety of light sources.

The diffuser has a light texture. This is to prevent Newton rings occurring when the film is in contact with the surface of the diffuser.

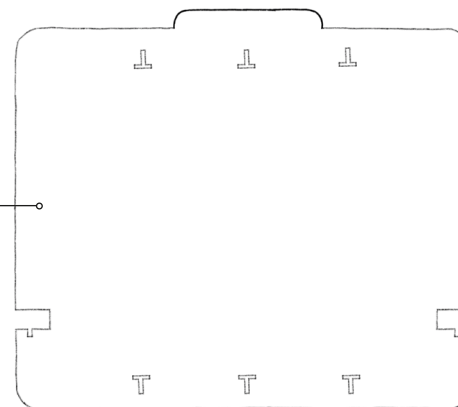

FRAME

The frame holds the film in place.

In the case of 4×5 film, this is on all four edges.

With 35mm and 120 roll film, the frame has a cutout on each side so the film is held flat to the diffuser when in use and allow the film to be pulled through pixl-latr between the digitisation of each frame.

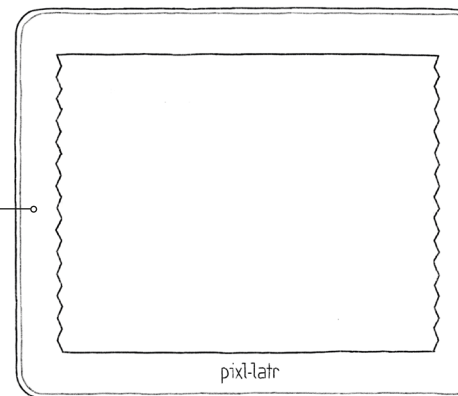

GATES

The job of the gates is to hold 120 and 35mm roll film flat to the diffuser. The gates come in two types; horizontal and vertical, which are numbered and labeled on the rear of each gate.

The horizontal gates hold the film along the edge of the whole strip.

The vertical gates hold the film at, or close to, the edge of the frame being digitised.

LEGS

The legs allow pixl-latr to be used upright in front of a light source such as a window or lamp.

Without legs in place, pixl-latr can be used laid flat on the screen of a tablet or photographic light table.



01



02



03



04

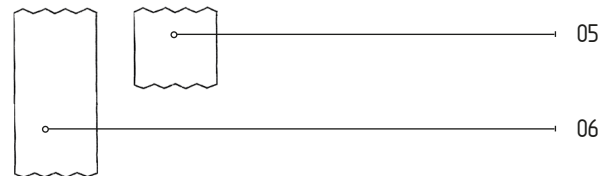

05



06

- | | | |
|----|-------|---------------------|
| 01 | | gate 1 - 35mm-B / 1 |
| 02 | | gate 2 - 35mm-T / 2 |
| 03 | | gate 3 - 120-B / 3 |
| 04 | | gate 4 - 120-T / 4 |
| 05 | | gate 5 - 35mm-V / 5 |
| 06 | | gate 6 - 120-V / 6 |

DIGITISING 4×5 FILM

To load a sheet of 4×5 film into pixl-latr, simply lay the frame face down and locate the film, emulsion side down, into the frame. The notches will be located at the top of the right-hand edge.

Tip: *The base is the more reflective side of the film, with the emulsion side being slightly matte in finish.*

The rear of the frame has a total of 8 film guides for 4×5 film: 3 along the top and bottom and one on each side.

These locators are slightly oversized to the sheet of 4×5 film.

This is to allow the film to be adjusted slightly to avoid much, if any, cropping of the image.

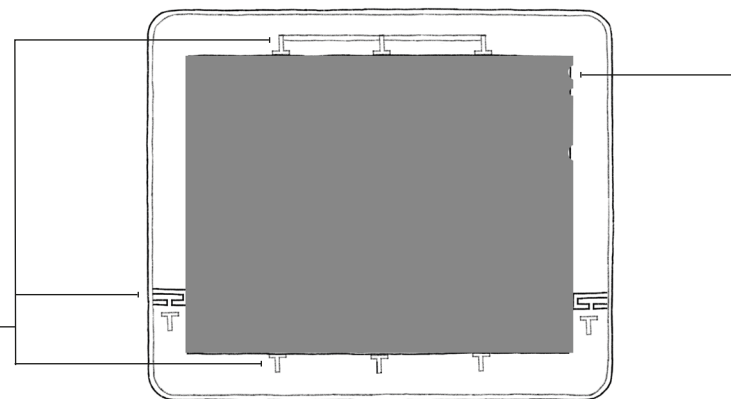

DIGITISING 4×5 FILM CONTINUED

Once the film is located into the frame, place the diffuser onto the back of the frame so the locators line up with the slots in the diffuser.

The diffuser slots into the frame to hold the sheet of film against the inside edges on all four sides.

Once the diffuser is inserted, pixl-latr can be flipped over and placed onto a desktop light source.

Alternatively, the legs can be slotted into the back of the frame and pixl-latr may be placed in front of a light source such as a window or lamp (as illustrated on page 16). A digital photo can now be taken of the film.

Note: *It is important to keep the digital camera as parallel as possible to the surface of the film to ensure even sharpness across the image.*

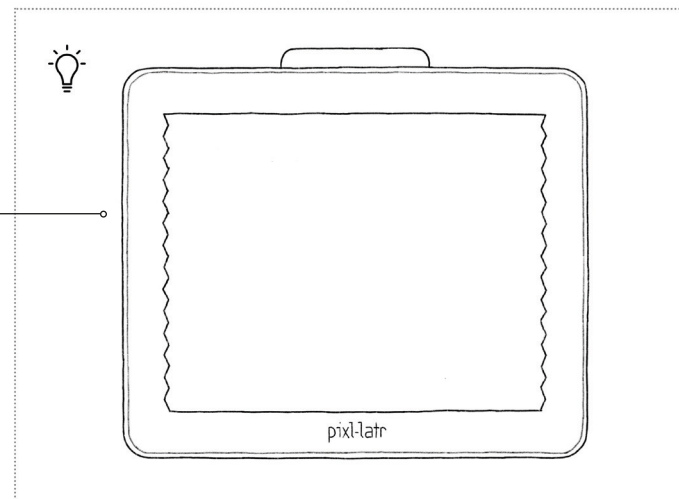
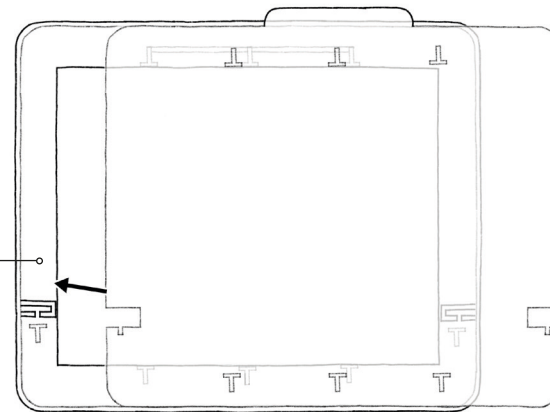

DIGITISING ROLL FILM (35mm & 120)

Prior to inserting your roll film into pixl-latr, the horizontal gates should be loaded into the frame. The gates slot into the frame with a light friction fit.

If you are digitising 35mm, insert gates 1, 2 and 4.

If you are digitising 120, insert gates 3 and 4.

To insert roll film into pixl-latr, lay the frame with the horizontal gates face down and locate the film emulsion side down into the frame.

The rear of the frame has two slots on either side with film guides at the bottom. Place the film into the slots so the edge of the first frame to be digitised meets the right hand inside edge of the frame.

Once the film is located into the frame, place the diffuser onto the back of the frame so the locators line up with the slots in the diffuser. The diffuser slots into the frame with a light friction fit to hold the strip of film tightly.

35mm film

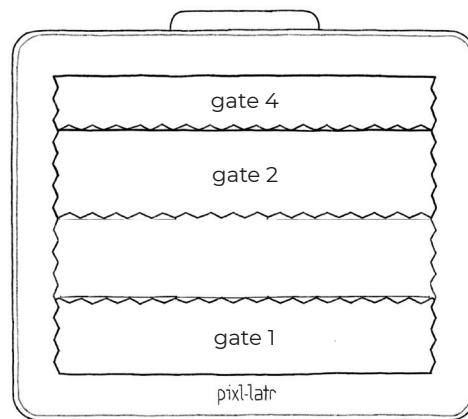

120 film

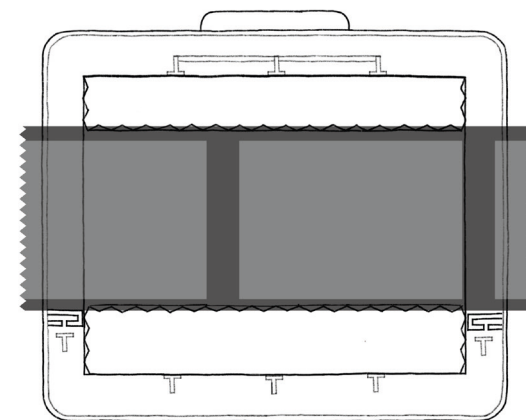
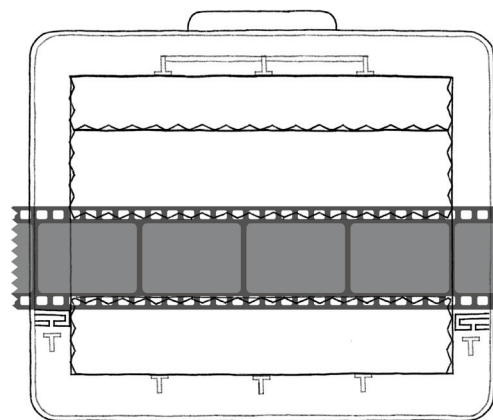
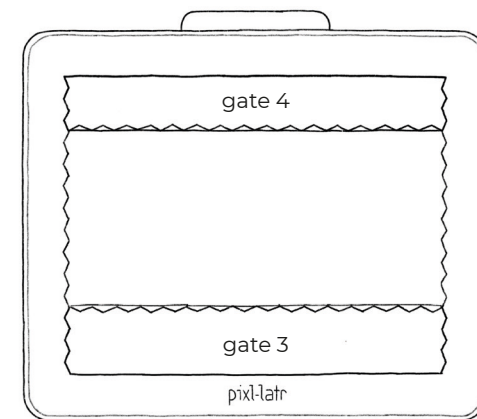

DIGITISING ROLL FILM (35mm & 120) CONTINUED

Once the diffuser is inserted, pixl-latr can be flipped over and placed face up. The vertical gate can now be inserted into a position that is most suitable for the image size on the film.

Note: *The 35mm vertical gate (gate 5) has arrows on the back. The gate should be located with the arrows pointing towards the top of the frame.*

With the vertical gate inserted, light pressure can be applied to the gates and the frame to ensure the film is tightly held around the image on the negative. This is to ensure it is held as flat as possible.

pixl-latr can now be placed onto a desktop light source (as illustrated on page 12). Alternatively, the legs can be slotted into the back of the frame and pixl-latr can be placed in front of a light source such as a window or lamp. A digital photo can now be taken of the film.

Note: *It is important to keep the digital camera as parallel as possible to the surface of the film to ensure even sharpness across the image.*

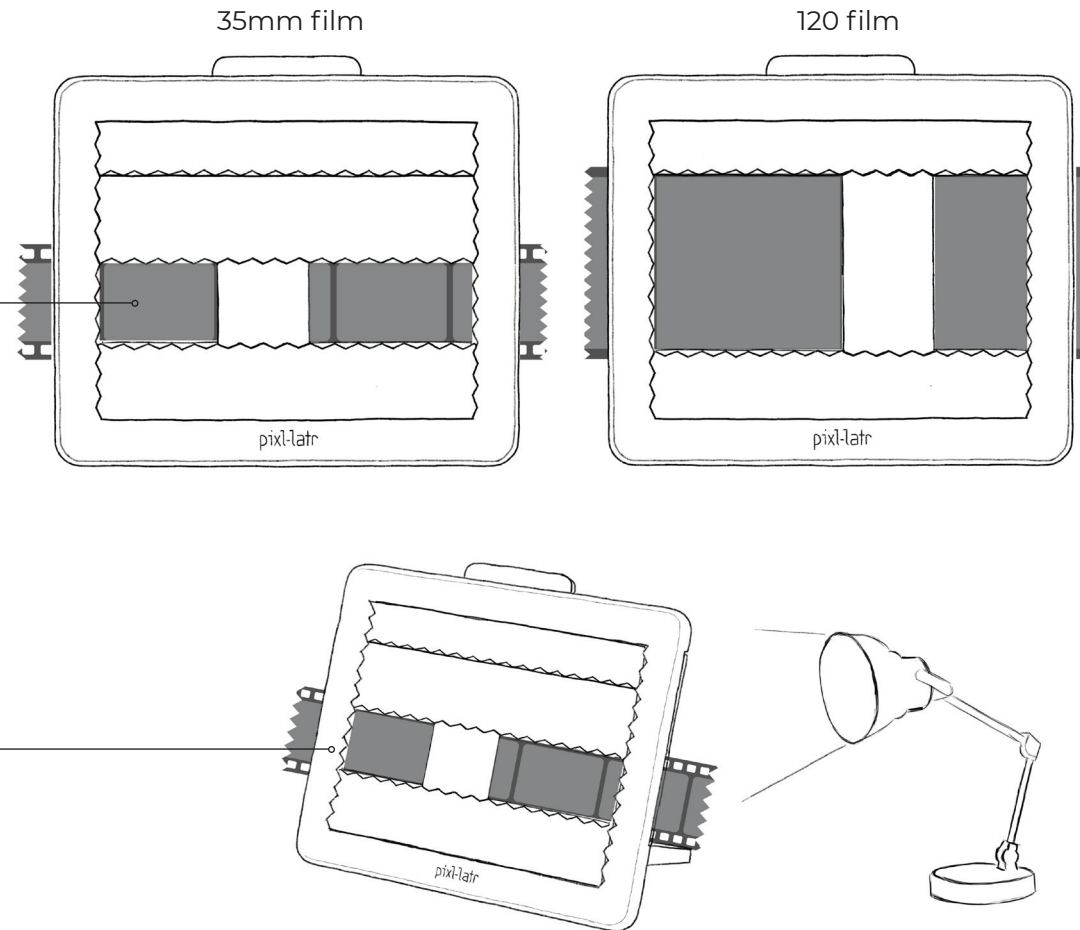

DIGITISING ROLL FILM (35mm & 120) CONTINUED

Once the first photo is taken, lightly prise the top part of the frame from the diffuser as illustrated. This will release pressure on the film so that the film strip may be moved through pixl-latr until the next image for digitisation is visible in between the gates.

Reapply pressure to the frame and gates to clamp the film and capture your next image.

Note: *It is important to lift the frame and gates to move the film through pixl-latr. Moving the film without lifting the frame may result in damage to the surface of the film.*

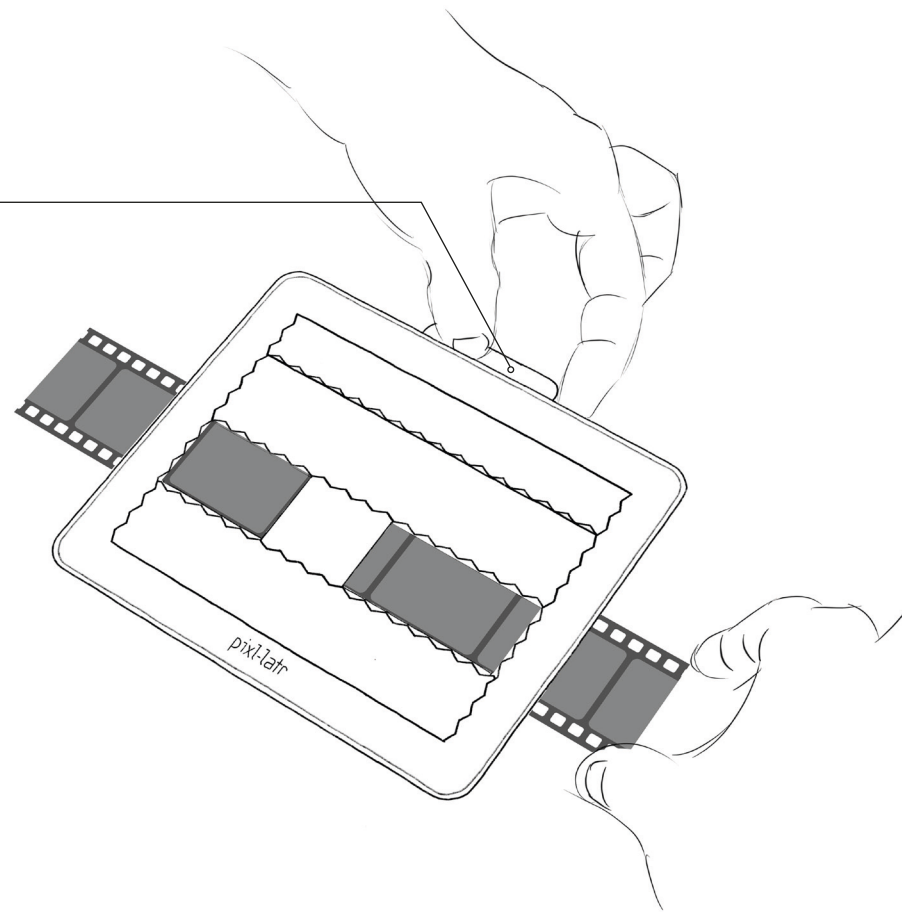

GET INVOLVED!

Keep an eye on **pixl-latr.com** for tips, articles and addons!

FOLLOW US!



[/groups/pixllatr/](#)



[/HamishGill](#)



[/pixllatr](#)



hello@pixl-latr.com
