



JOBBO International GmbH • Kölner Str. 58a • 51645 Gummersbach • Germany

JOBBO Lift CPE-2/2plus/3

Bedienungsanleitung Operating Instruction



Technische Änderungen vorbehalten / Subject to technical modifications

Der JOBO-Lift macht das Arbeiten schneller, gleichmäßiger und einfacher. Tanks und Drums werden während der Rotation sicher gefüllt und entleert. Es wird eine optimale Benetzung erreicht. Nasse Finger während des Prozesses gehören der Vergangenheit an. Es können die Systeme 1500, 1500 und 2800 mit Zahnkranz verwendet werden.

Lieferumfang

Lift / Montageplatte (schwarz) / Lifthebel / Rollen / Zahnrad / Befestigungsschrauben / Bedienungsanleitung

Montage Zahnrad

Magnetkupplung vom vorhandenen Colorprozessor abschrauben und das mitgelieferte Zahnrad fest aufschrauben.

Sollten Sie den CPE-3 mit einem Lift im Kit erworben haben entfällt dieser Punkt

Liftmontage

Montageplatte vom Lift lösen. Montageplatte mit den beiliegenden Schrauben (3 Stück) auf dem CPE befestigen.

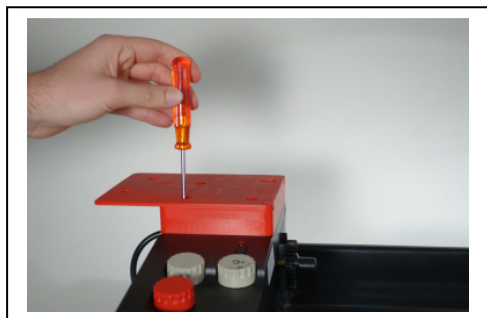
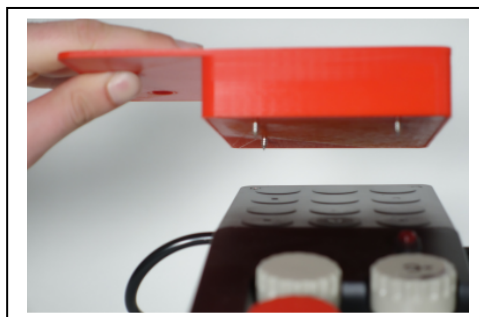
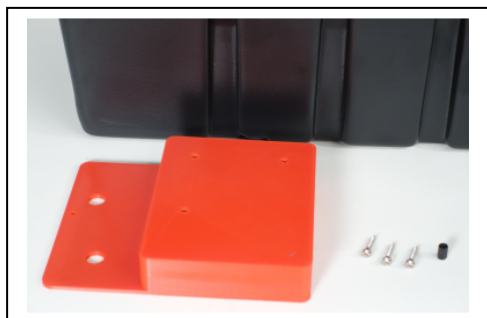
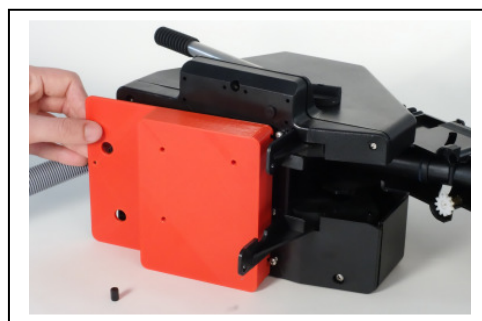
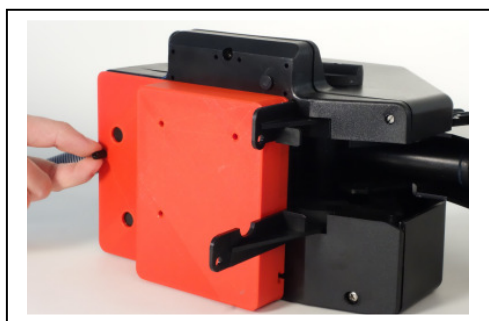

Schraube seitlich neben dem Zahnrad lösen und zur Seite legen.

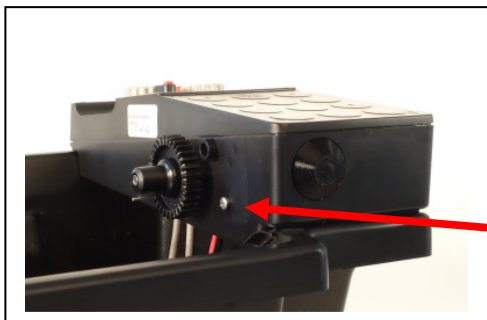

Lift auf die Montageplatte bis zum Anschlag aufschieben und verschrauben

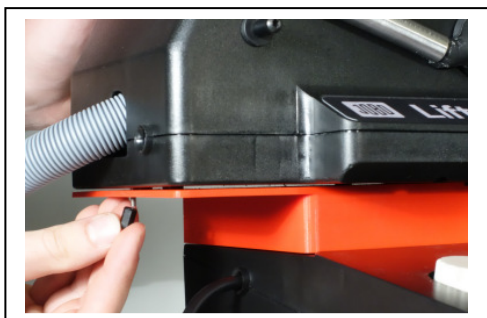
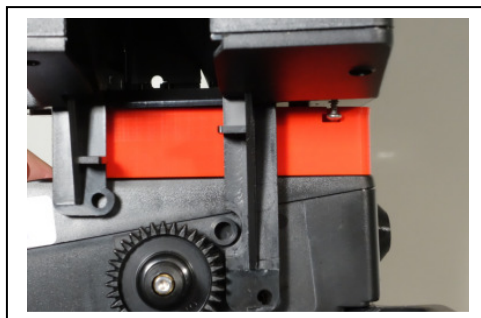
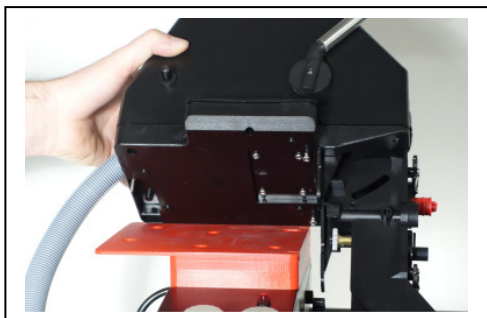

Lift mit Schraube auf der rechten Seite des Motorkopfes verschrauben.



Montage Lifthebel. Lifthebel aufstecken und im Uhrzeigersinn festdrehen.



Anwendung

Tank/Drum ankuppeln

Den Tank an den Lift ankuppeln. Bitte achten Sie hier auf die korrekte Position des Rollenbocks.

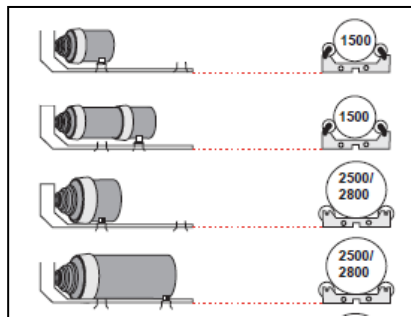
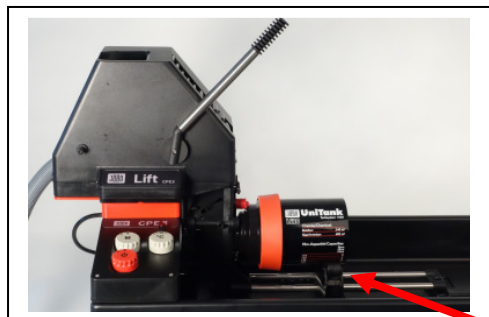

Tank/Drum entleeren

Lifthebel umschwenken, die Chemikalie fließt in die von Ihnen bereitgestellte Auffangflasche.



maximale Tank- und Drumkombination mit dem CPE3 inkl. Lift

System 1500 Tank 1510 mit max. 2 Modulen 1530

System 2500 bis Tank 2550

System 2800 bis Tank 2840

The JOBO Lift makes work faster, smoother and simpler. Tanks and drums are filled and emptied efficiently during rotation. Optimal wetting is achieved. Wet fingers during the process are a thing of the past! Systems 1500, 2500 and 2800 can be used with cog

Content

Lift unit / mounting plate (black) / lever / rollers / gear / mounting screws / instruction manual

Fitting of toothed gear

Unscrew the magnetic coupling from the existing CPE processor and screw the toothed gear provided tightly into position.

In case you have bought the CPE3 Kit with Lift this point is obsolete.

Assembling the Lift

Remove mounting plate from lift. Insert the enclosed screws into the mounting plate (3 pcs.)

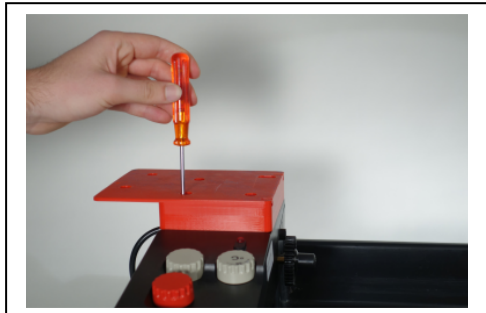
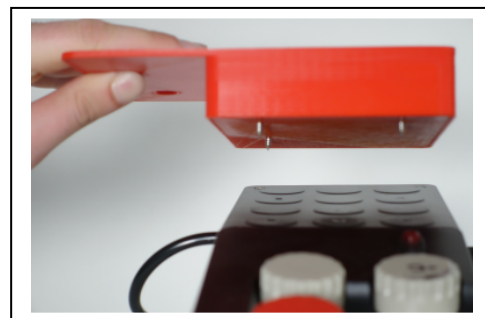
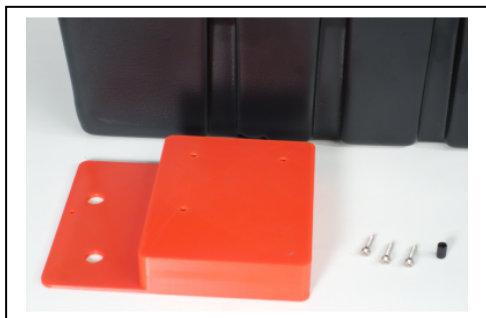
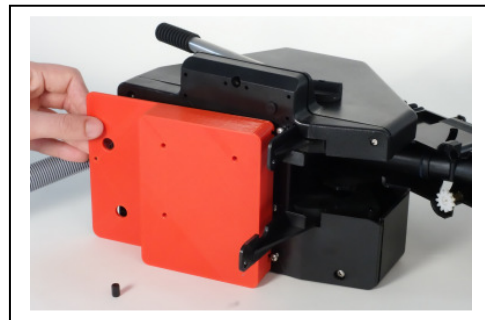
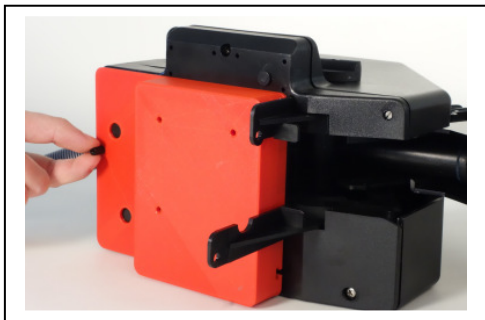

Loosen the screw on the right-hand side of the motor control unit and put it aside.

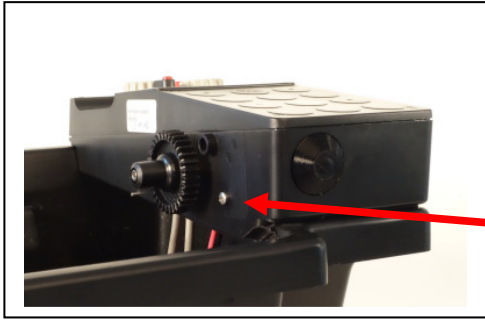

Slide lift onto mounting plate until the stop is reached and screw into position.

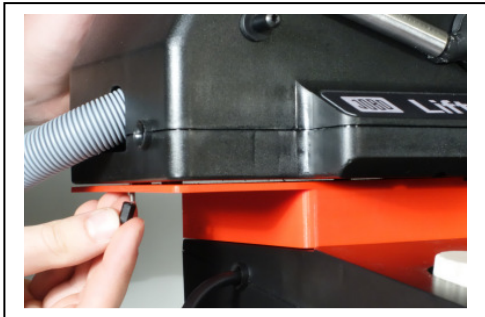
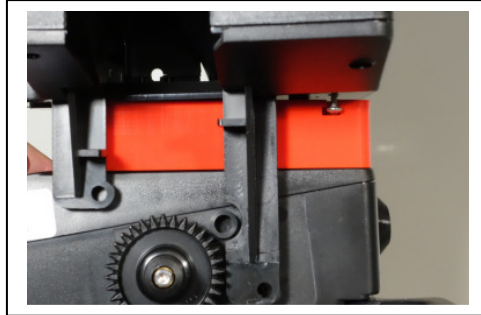
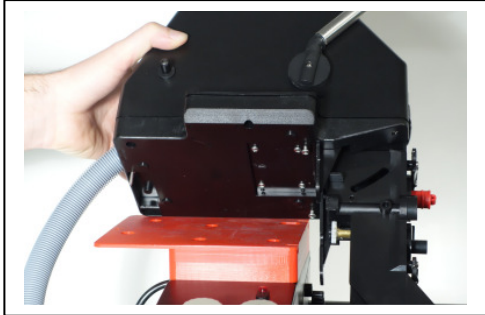

Screw lift into position on the right-hand side of the motor control unit using the screw you unscrewed before.



Fitting the Lift lever

Insert the Lift lever and screw tight in clockwise direction.



Usage

Connection a tank/drum

Put the tank to the lift arm. Adjust the roller block for tank/drum system and position according to the length of the tank

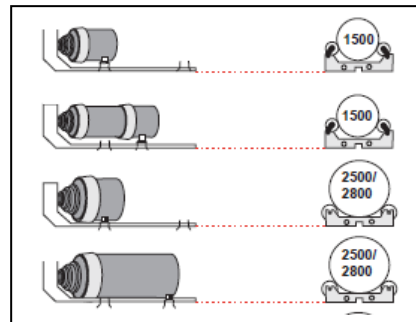
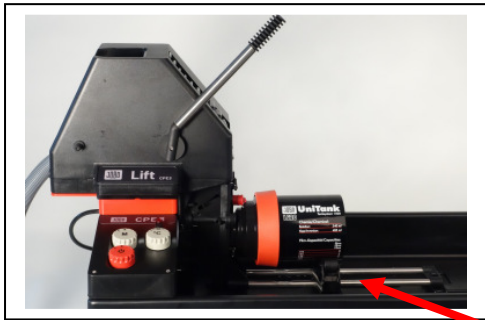

Emptying a tank/drum

Pull down lift lever; the chemical flows into a collecting bottle that need to be put under the outlet.



Maximum Tank or Drum combination that fits with the CPE3 incl. Lift

System 1500 Tank 1510 with max. 2 modules 1530

System 2500 up to tank 2550

System 2800 up to tank 2840