

USER MANUAL

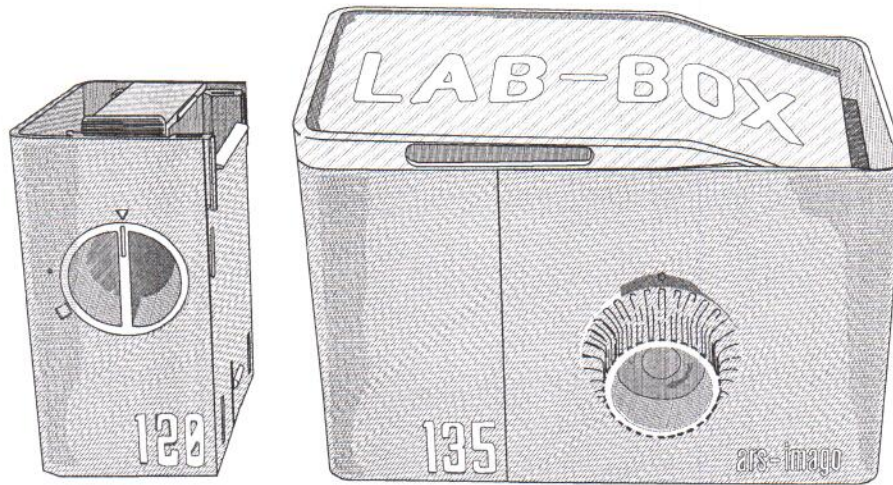

LAB-BOX

lab-box.it/tutorials

|Preface |

WHY LAB-BOX

Interest in analogue photography is growing. New generations of digital natives are rediscovering the analogue process as something new to experiment with.

This is why we have decided to create a product that would easily allow anyone to develop film rolls in full daylight, indoor or outdoors. Lab-Box addresses the needs of those just getting started with film photography and, at the same time, it is a tool with great potential for professionals and advanced users.

WHAT IS LAB-BOX

Lab-Box is a multi-format tank and can be used for both 35mm and 120 films, thanks to the two interchangeable modules and adjustable reels. The films are loaded in full daylight and are wound onto the reel using the outer knob., without the need to be in a darkroom. Lab-Box is the easiest and quickest tool to develop your own films in full day light, anywhere and at anytime, bypassing the need to load the rolls in the dark. Lab-Box is the result of long research and developing efforts, paired with an effective and beautiful design.

CROWDFUNDED

Lab-box is a crowdfunded project and it became reality thanks to the Kickstarter platform and to all the 4791 backers that contributed and supported us from all over the world.

Lab-Box is a project by

ars-Imago

Design and prototyping are by VIVO Design Studio, in Rome, Italy

INDEX

**User
Manual**

Contents.....	4
Lid&Tank.....	6
Film Guide.....	7
Module 135.....	8
Module 120.....	9
How to change modules.....	10
Knob & Crank.....	12
Reels & Hub.....	13
Assembling reels.....	14
How to load your 35mm film.....	16
How to load your 120 film.....	24
Chemicals process.....	32
Processing film.....	33
Preparation of liquids.....	34
Pouring and emptying chemicals.....	35
Developing, stopping and fixing.....	36
Agitation.....	37
Washing & Wetting agent.....	38
Drying.....	39
Trouble shooting.....	42
Technical Information.....	46

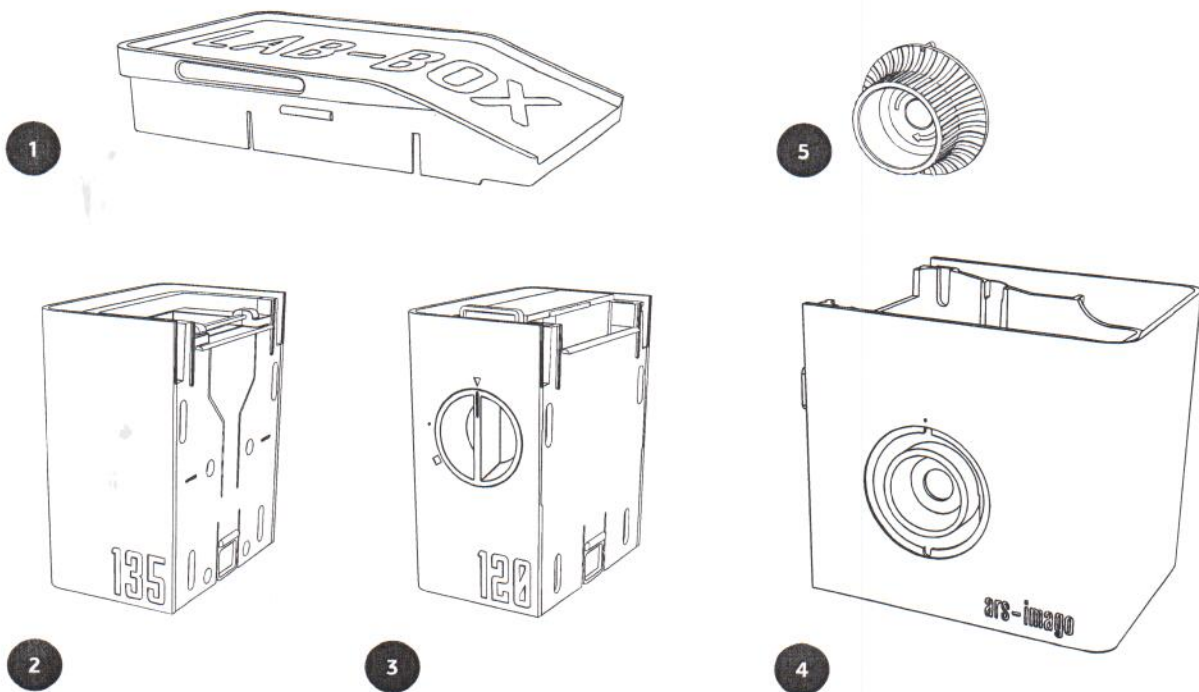



6



7

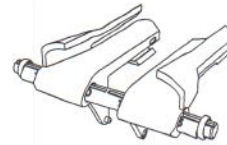

8

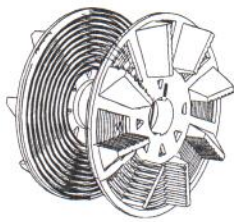

9

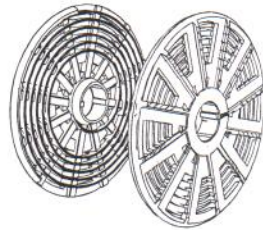

10

CONTENTS

1. LID
2. MODULE 135
3. MODULE 120
4. TANK
5. KNOB
6. CRANK (Accessory)
7. HUB
8. FILM GUIDE
9. 135 REEL
10. 120 REEL

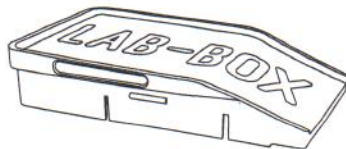

LID

The Lid was designed to let liquids in and out, yet being lightproof. Thanks to the side dentels, once in place, the Lid stably latches onto the tank to keep the light from leaking in. To remove the Lid, you need to pull it upwards perpendicularly to the tank; avoid oblique movements. Before starting a new process, make sure that the lid is completely dry, so to avoid drops to compromise the correct loading of the film.



TANK

The Tank is where the actual developing process happens. On the inside, the film wound onto the reel, comes into contact with the chemicals. The side hole holds a rounded gasket set out to prevent leaks during agitation through the external handle; it is necessary to make sure that the gasket stays clean and undamaged. On the back of the Tank are listed working liquid quantities: 300ml to fill half the tank and proceed with continuous agitation; 490ml to fill the Tank completely and proceed with intermittent agitation.



VIDEO - 1

FILM GUIDE

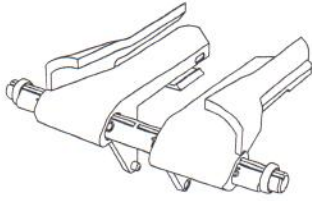

The film guide is a multi-format guide that enables film to be correctly wound onto the reel. One may set the guide for 135 format and 120 format. 135 format has a security lock to keep the slide in place.

To unlock the film guide and set it to 120 position, you need to pry onto the locking dentel below the slide while pushing sideways, until the two slides separate. It is important not to pry onto the upper extremity of the slide: plastic in that spot is very flexible and might break.

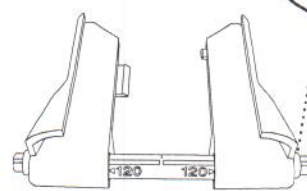
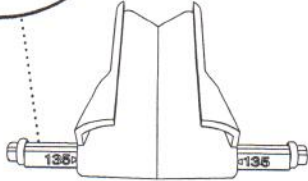
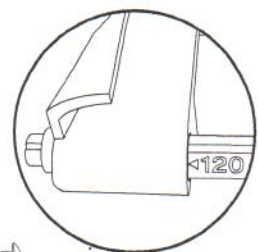
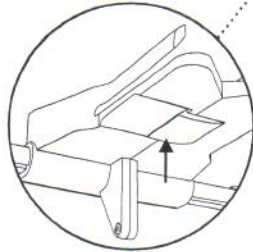
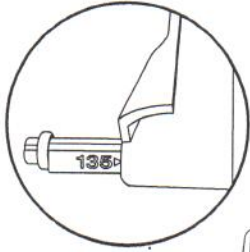

VIDEO - 2

MODULE 135

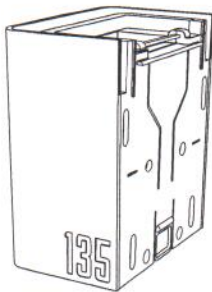

The 135 Module turns Lab-Box into a developing tank for 35mm films. Pushing the gray lever on the back activates a cutting blade that cuts off the film from the spool. The film must be slidden under the two metal tubes that will act as a counter-blade for cutting.

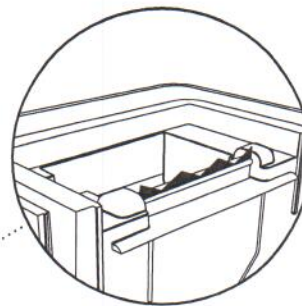
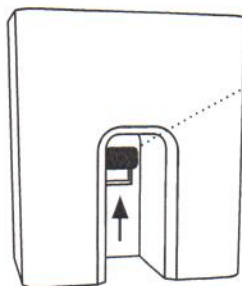
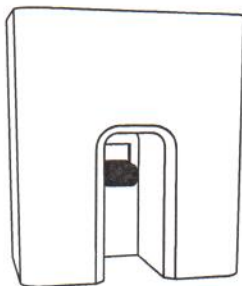



VIDEO - 3

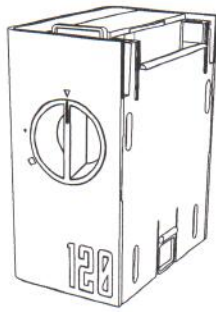

MODULE 120

The 120 module turns Lab-Box into a developing tank for 120 films. The module has a film chamber inside and a split on the outside to extract the black backing paper while the film is wrapped inside. The gray film block is used to press the 120 film roll against the film chamber and ensure that the film is wrapped correctly.

The external knob allows you to open (triangle position) or close (square position) the film chamber. Placing the knob at the point allows you to extract the piece. It is important that the film chamber be completely dry before using the module, otherwise the film loading can be compromised.

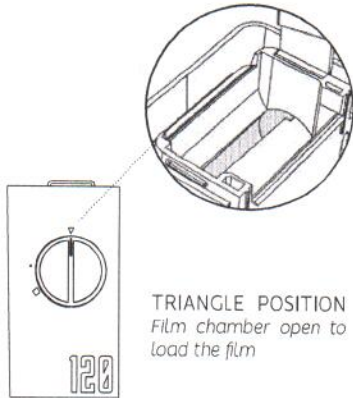

TRIANGLE POSITION
Film chamber open to load the film

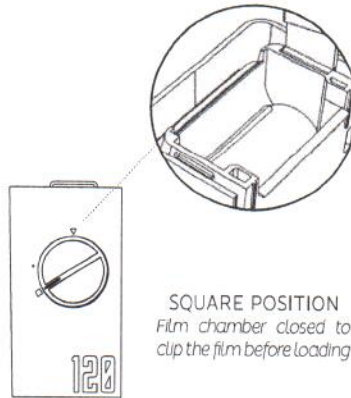

SQUARE POSITION
Film chamber closed to clip the film before loading

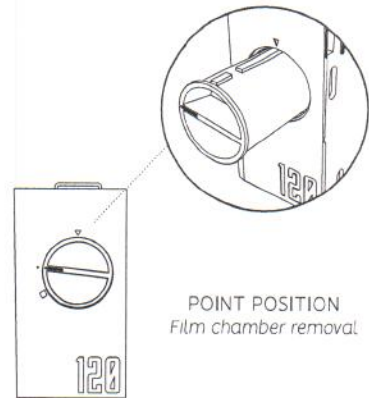

POINT POSITION
Film chamber removal



VIDEO - 4

CHANGING MODULES

Locking

Bring the module close to the tank by matching the holes of the module to the hooks on the back of the tank. At this point, while holding the tank firmly, push the module simultaneously towards the tank wall and down until you hear a click.

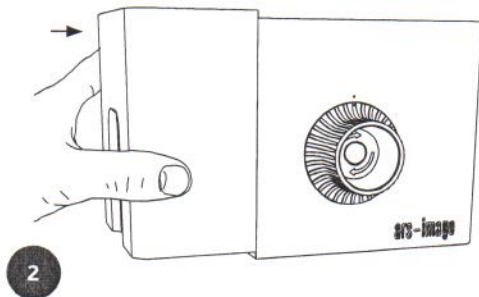

2

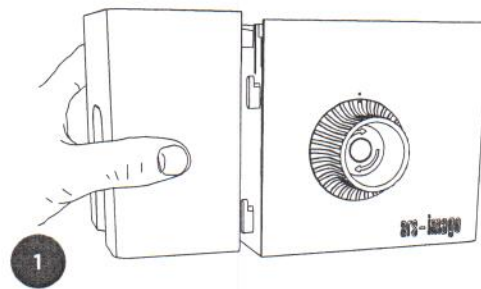

1

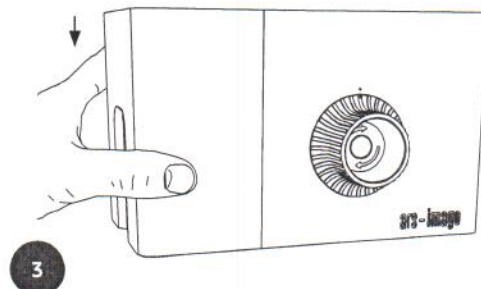

3



VIDEO – 4

CHANGING MODULES

Unlocking

To unhook the module press the small flexible tab present on the bottom between module and tank. While holding the tab pressed against the module, push the module simultaneously upwards and away from the tank, meanwhile push with the other hand the tank downwards until they unhook.

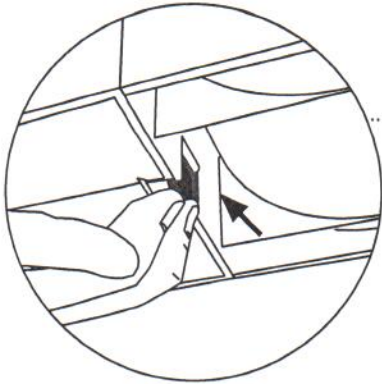

Module 120 can be slightly harder to unhook. Watch the video to check alternative methods to unhook more easily 120 modules.

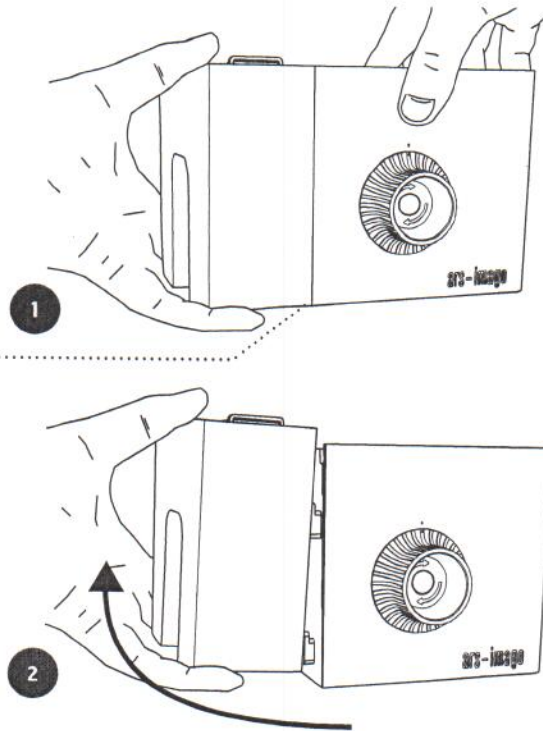

VIDEO – 5



KNOB

The Knob allows you to externally control the rotation of the internal reel. Before you insert the knob in place you must always make sure that the internal cylinder is clean not to damage the gasket. The Knob can only be inserted in and out by aligning the small symbol with the one on the tank.

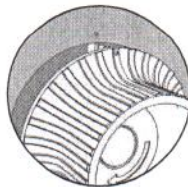

Match the point on the tank with the point on the knob to insert and remove it

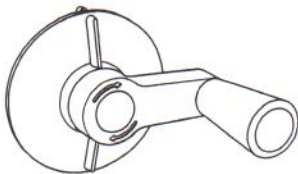

CRANK (accessory)

The Crank accessory eases the external control of the internal reel. It consists of two pieces: a fixed one and a movable one. Once you have inserted the disc aligning the plastic line with the symbol on the tank, turn the disc by 90 degrees to keep it locked. To uninsert the Crank, realign the line with the symbol and pull outwards. Before you use the Crank, check that the internal cylinder is clean in order not to cause damage to the gasket.

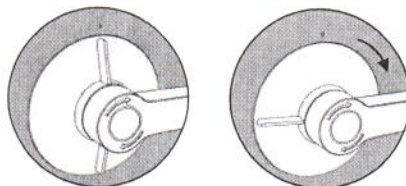

Insert the crank into the tank hole.
Turn the crank base by 90° until locked.

REEL HUB

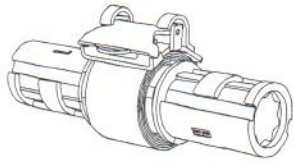

The multiformat hub allows you to mount reels 135 or 120 depending on the film format you want to develop. The 135 reels will lock on the inmost grooves. The 120 reels in the outmost grooves. On both sides there are an "L" (Left) and an "R" (right) and two arrows that will match those on the reels in order to mount correctly. The R side of the hole is, must appear to match the side of the tank knob.

At the center of the hub there are two slits to facilitate the flow of chemicals. In the smaller slot the strip is hooked with the clip that will wrap around the hub when the films are loaded into the spirals.

REELS 135 & 120

The Reels allow winding of the film inside the Tank. The Reels are designed to grant homogeneous flux during developing.

The 135 Reels feature external wings to aid agitation of liquids.

The 120 Reels are optimised to leave as much room as possible for the film.

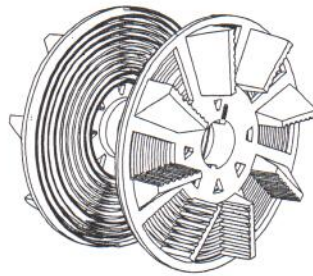

REELS 135

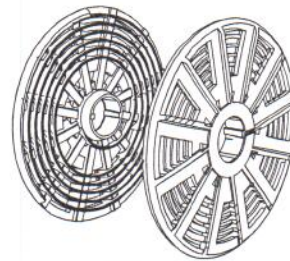

REELS 120



Assembling the 135 Reels

To assemble the 135 Reels, L and R symbols on the back of the reels must be aligned with the ones on the hub. Once you have inserted the reel from the correct side, the arrow on the reel and the arrow on the hub must be aligned. Now, push the reel to the end, until it touches the hub's central pivot. Finally, you must lock the reel by rotating the two reels in the opposite direction as shown in the picture. You will hear the reel locking after clinging one dentel. To disassemble the reels, proceed backwards.

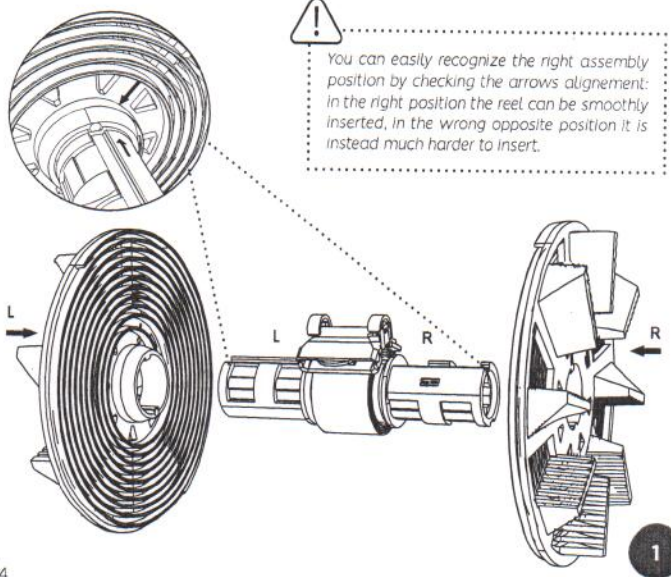



Assembling the 120 Reels

To assemble the 120 Reels, L and R symbols on the back of the reels must be aligned with the ones on the hub. Once you have inserted the reel from the correct side, the arrow on the reel and the arrow on the hub must be aligned. Now, push until it coincides with the first slot; to lock it, rotate the two reels in the opposite direction as shown in the picture. You will hear the reel locking after clinging one dentel. To disassemble the reels, proceed backwards.

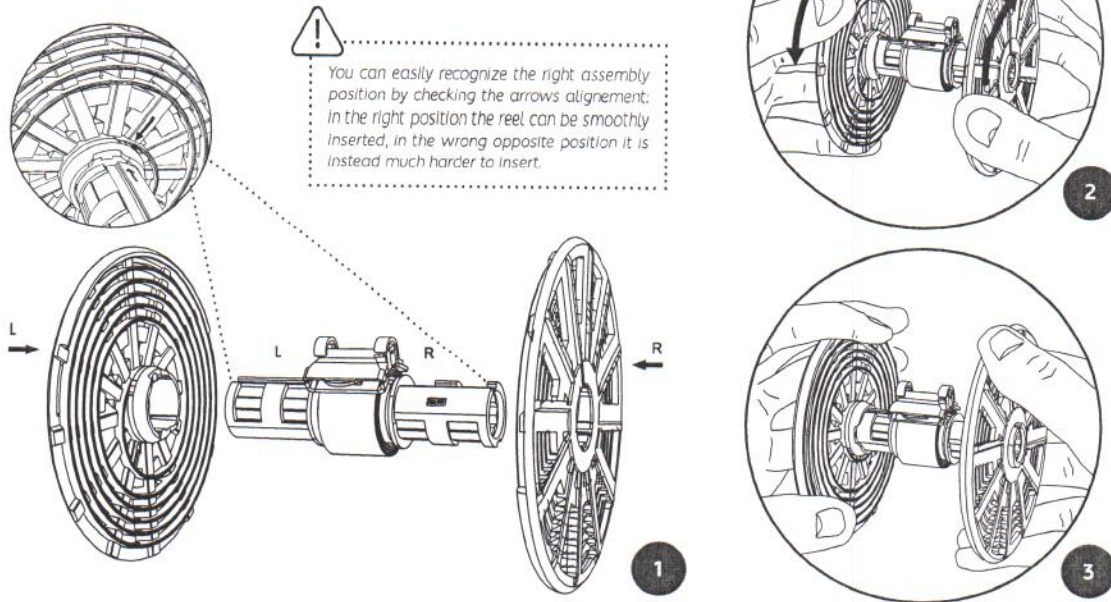

HOW TO LOAD YOUR 35MM FILM

www.lab-box.it/tutorials



Scan the QR Code with your phone to watch the video tutorial

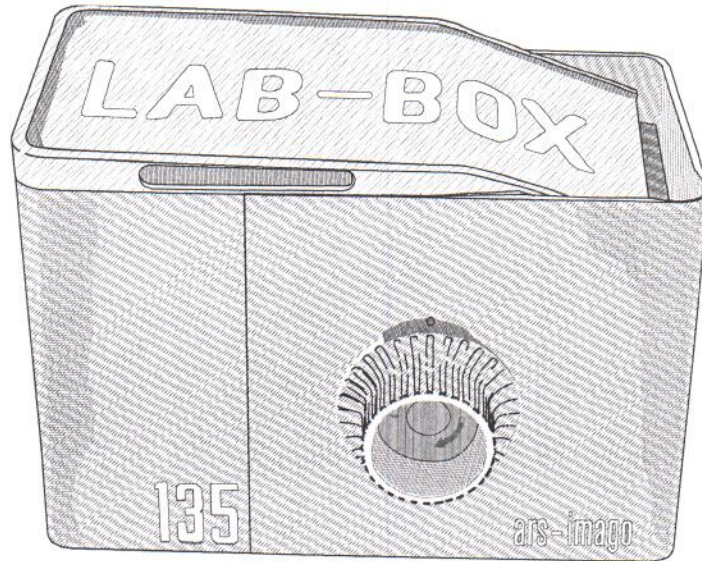
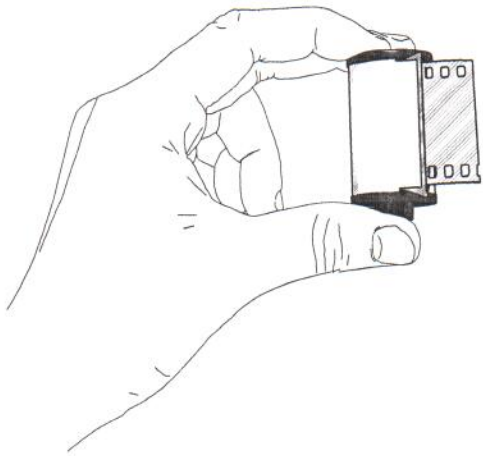

CHECK LIST before you start

- 1 Check the film guide is in correct position 135, properly closed and dry.

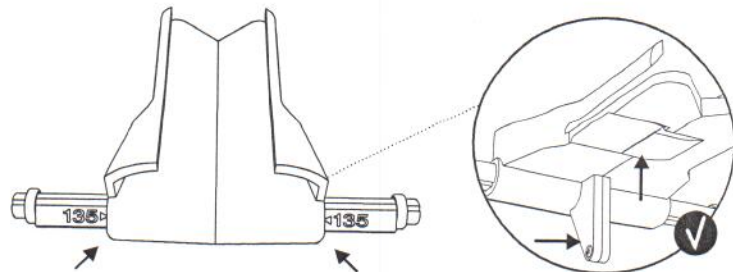

- 2 Check that the 135 reels are in correct position and properly aligned. Follow L, R and arrows reference on the reels and the hub.

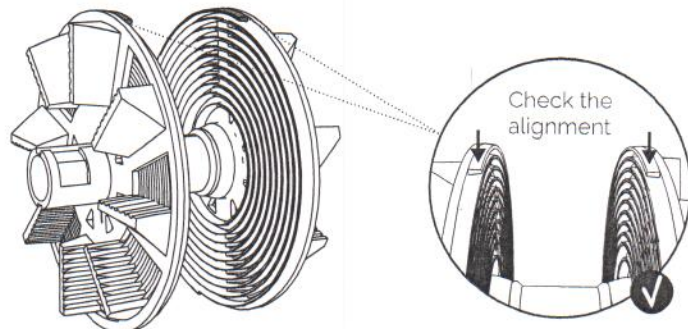

- 3 Check again that all the elements are properly aligned and that the blade is not visible.

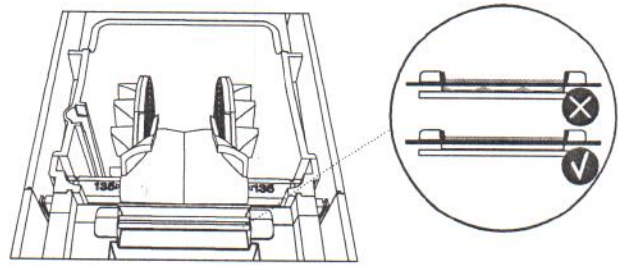

- 4 Pay attention to clipping the film as much as possible in the center.

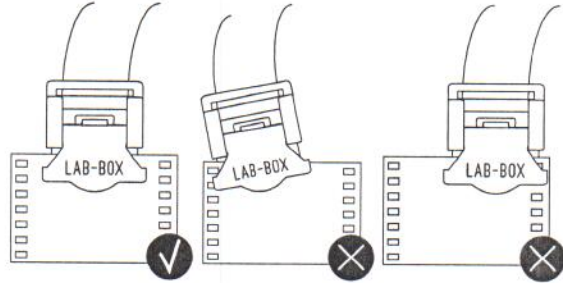

Films with P.E.T. base are much harder to clip and to cut.
Here you can find an updated list of P.E.T. base films: www.lab-box.it/petfilmlist

INSTRUCTIONS

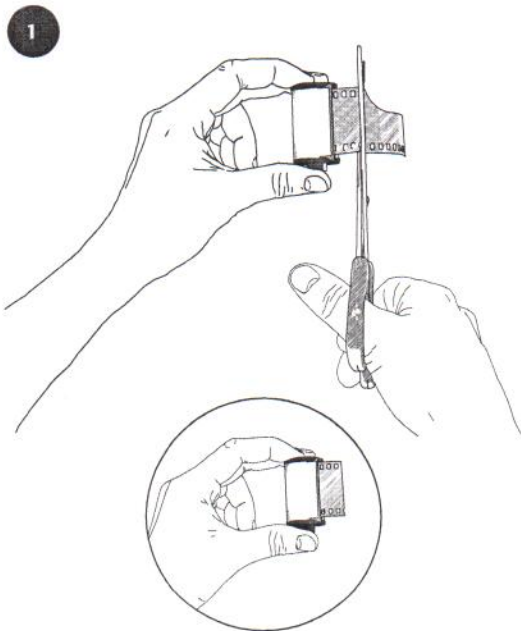

Take your exposed 35mm film and cut the film tail.

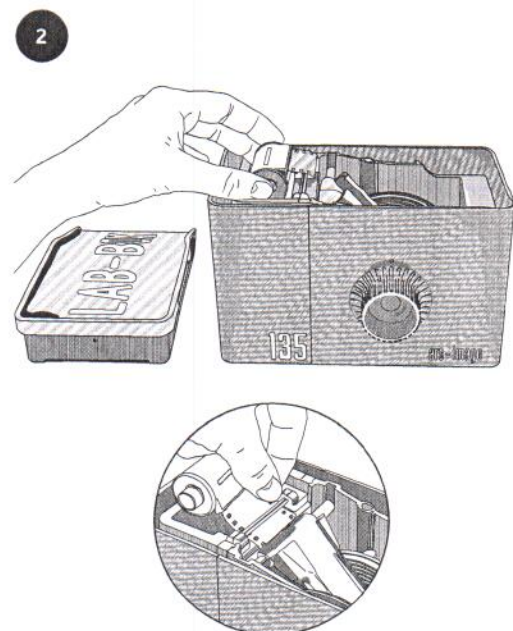

Open the lid and place the roll in the film slot. Then slide the film under the two metal pins.

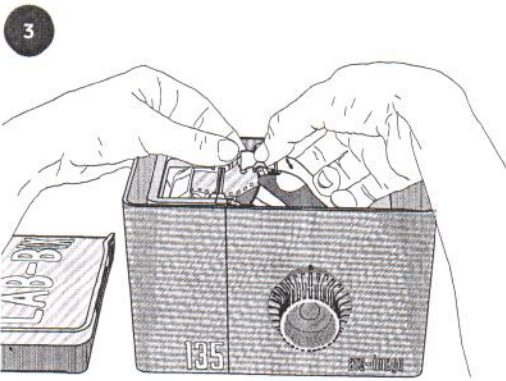

Take the metal clip and hook the film: press the clip with your fingers until you hear a click.

Pay attention to clipping the film as much as possible in the center.



Turn the outer knob until the hooked film starts to slide correctly through the film guide.

21

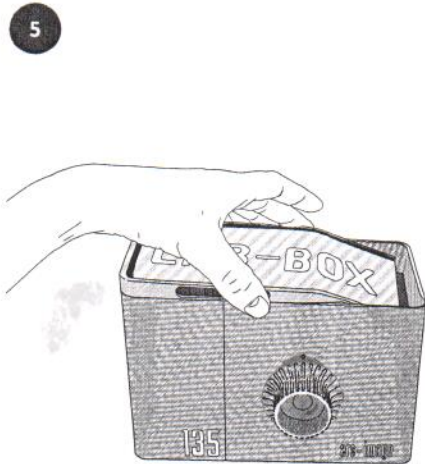

Close the lid and turn the outer knob in order to wind the film onto the reel.

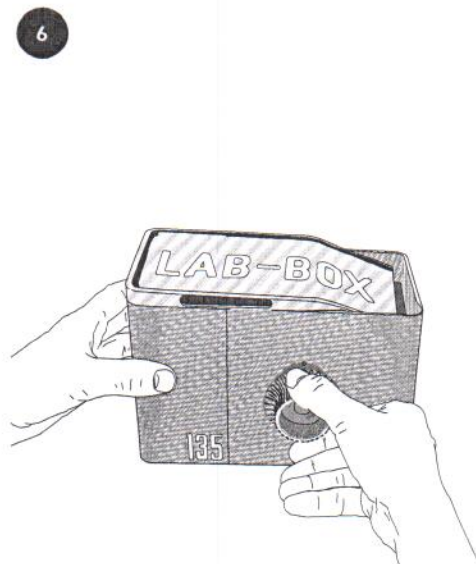

When the knob stops to turn, it means that you have reached the end of the roll.

7

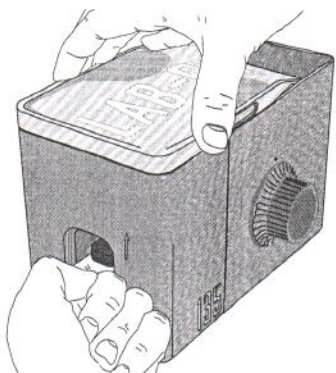

Now, push up the grey lever on the back to cut the film from the cartridge.

8

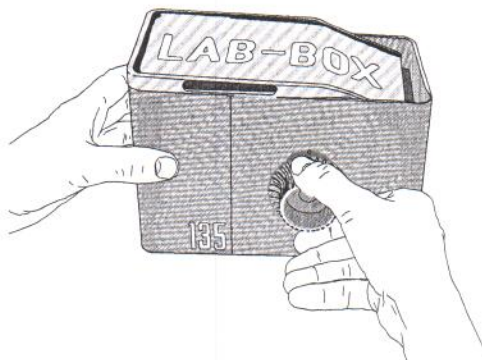

Once you have cut the film, turn the knob gently to wind the last part of the film onto the reel. Now you can start processing your film

HOW TO LOAD YOUR 120 FILM

www.lab-box.it/tutorials



Scan the QR Code with your phone to watch the video tutorial

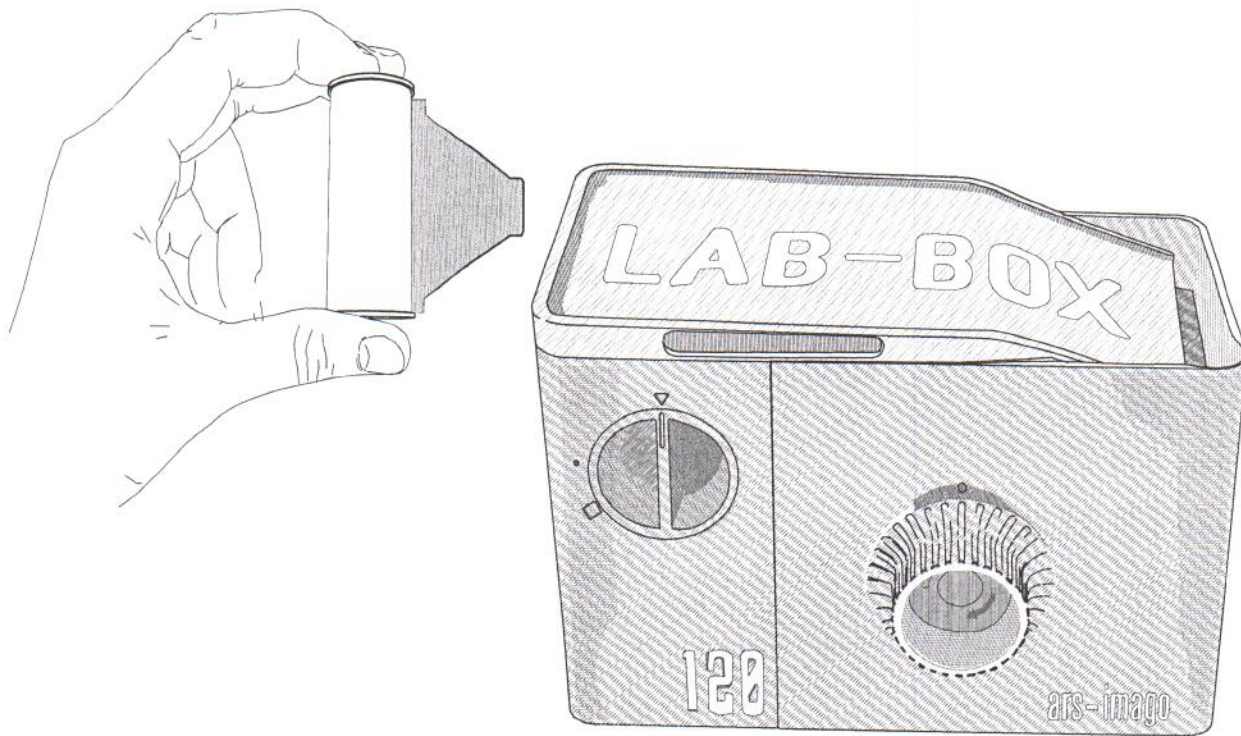

CHECK LIST before you start



Partly exposed films which are in the camera for more than one week lose their curling quality. To regain this quality which is necessary for threading, the film must lie rolled up tightly for at least one day.

- 1 Check the film guide is in correct position 120, properly open, touching the external rings and dry.

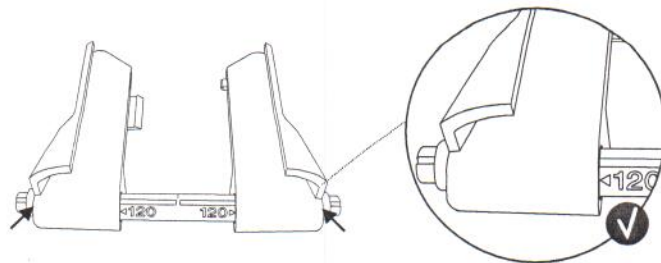

- 2 Check the 120 reels are in correct position and properly aligned. Follow L, R and arrows reference on the reels and the hub.

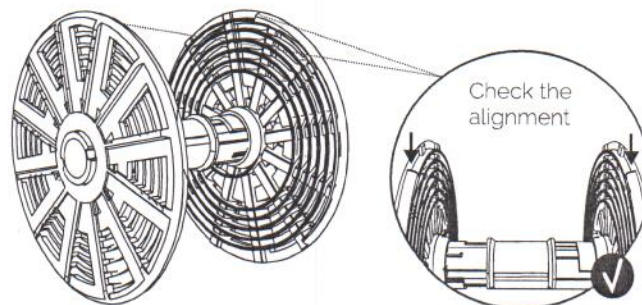

- 3 Check the 120 knob is on "▽" symbol to open the film chamber.

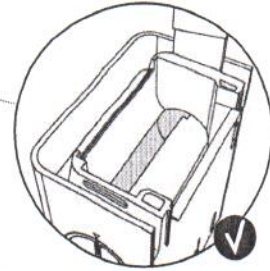
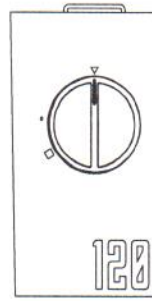

 Module and film chamber must be dry

- 4 Pay attention to clipping the film as much as possible in the center.

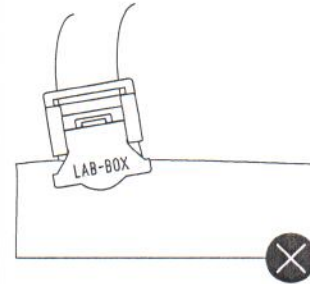
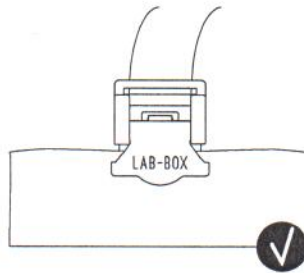

Films with P.E.T. base can't be used with Lab-box.
Here you can find an updated List of P.E.T. base films: www.lab-box.it/petfilmslist

INSTRUCTIONS

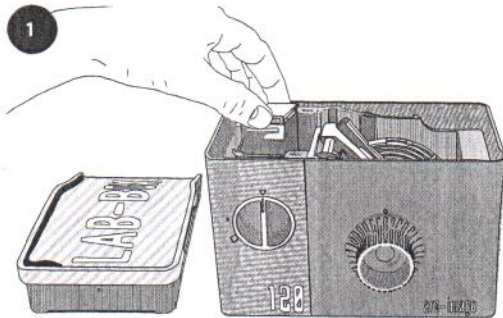

Take your 120 exposed film, open the lid and open the module grey lock. Be sure the 120 knob is in open position (triangle symbol).

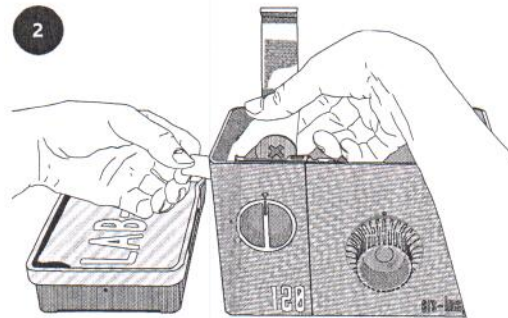

Insert the black backing paper in the rear split and place the roll in the film slot. Then close the grey block and close the lid.

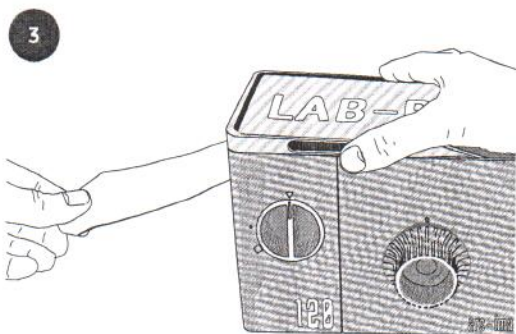

The film will be automatically wound in the lower lightproof slot behind the 120 knob.

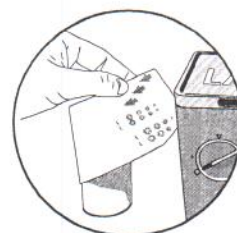
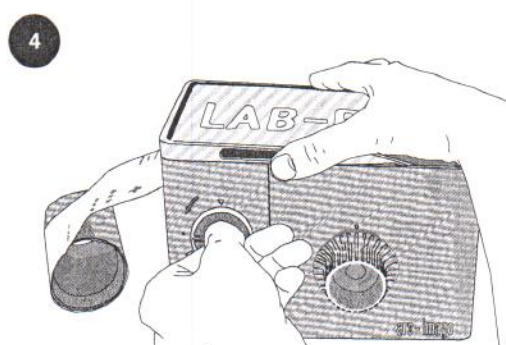

Pull the paper out through the split: when it has come all out it will offer resistance and you will see three arrows and "1" on the paper.

Turn the 120 knob counter-clockwise into closed position (square symbol). Now you can tear away the paper.

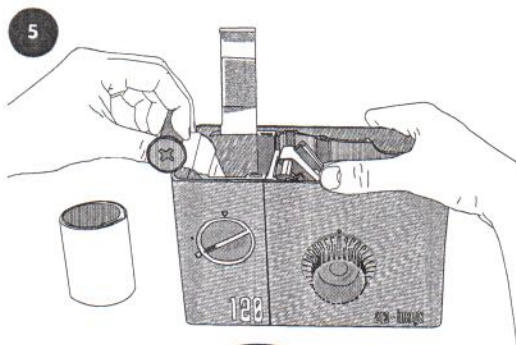

Open the lid and, being careful not to pull out the film, remove the spool, the excess backing paper and the adhesive from the film.

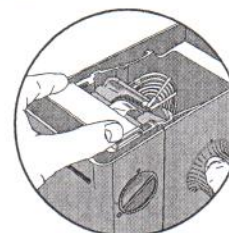
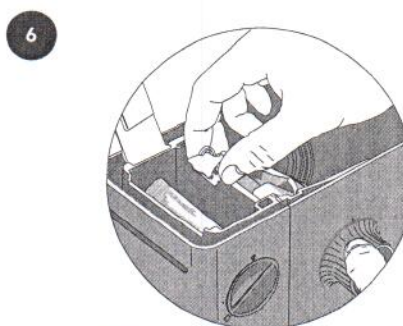

Take the metal clip and hook the film: press the clip with your fingers until you hear a click, then close the grey block.

Pay attention to clipping the film as much as possible in the center.

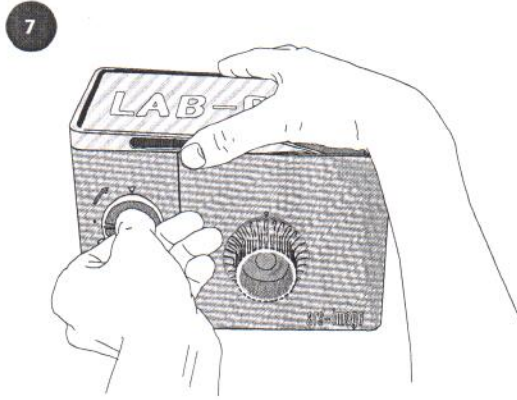

Close the lid and turn again the 120 knob (triangle position) to open the lightproof chamber and release the film.

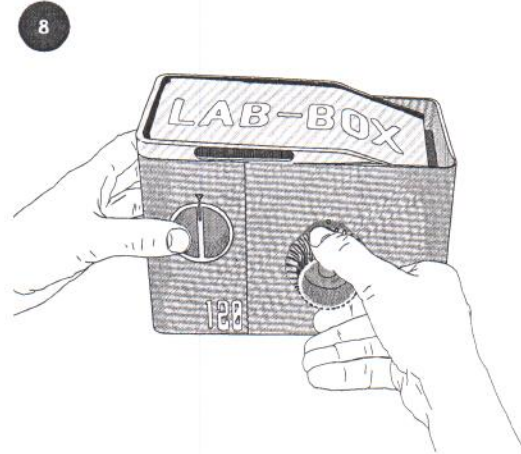

Turn the tank knob gently in order to wind the film onto the reel. Now you can start processing your film.

CHEMICALS PROCESSES

Monobath

Monobath process allows to develop black and white film quickly and easily with only one solution and in a few minutes.



Black and White

The standard Black and white process consists of 4 baths: Developer, Stop, Fixer and Wetting Agent.



Color Negative – C41

The C-41 process allows to develop color negative films. It requires a precise temperature control.



Process your film

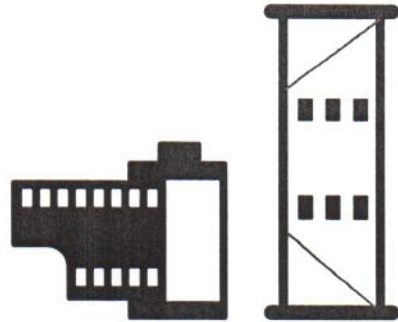

33

| Contents - PREPARATION OF LIQUIDS |

Preparation of liquids

Liquids must be prepared and brought to temperature before starting the process. For black and white, the recommended standard temperature is 20°C (68°F). If you decide to use continuous agitation, prepare 300ml of chemistry. In case of intermittent agitation, prepare 490ml and be very careful not to pour more than 500ml, otherwise liquid can leak out of the tank.

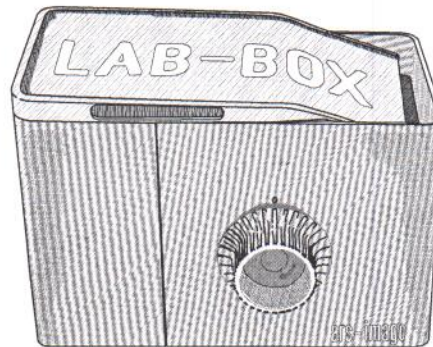
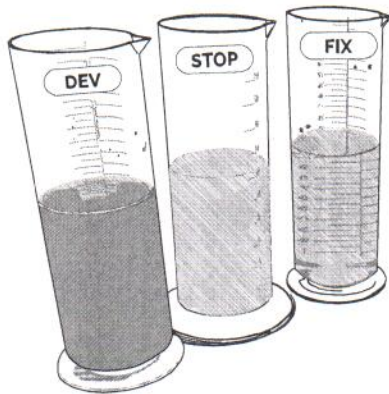

34

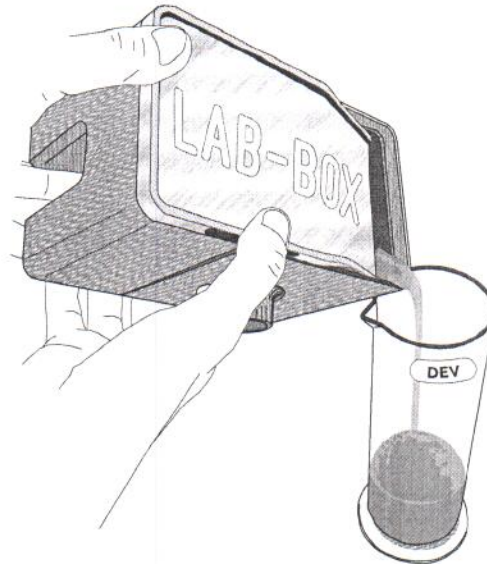
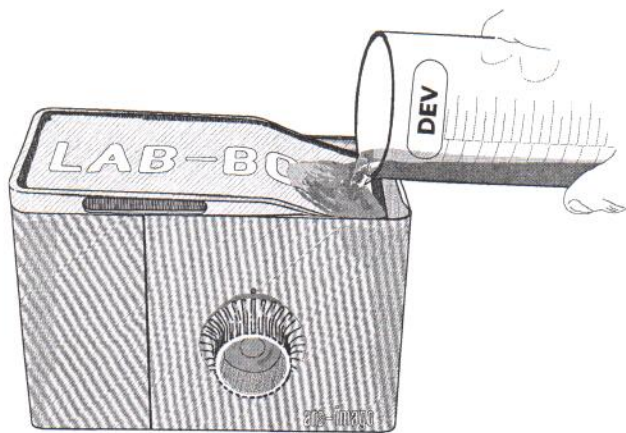

Pouring and emptying chemicals

Once the lid is closed, the chemicals can be inserted into the tank by pouring them from the frontal part of the lid. We recommend placing the cylinder or carafe in the center of the tank edge to speed up the process as much as possible, being careful not to let the liquid flow out from the edges of the filling space. The emptying must not be carried out too quickly by heavily inclining the tank, otherwise liquid could pour out from the back. In the event that this happens, the process remains unaffected.

35

DEVELOPING

Development is the most important part of the process as it will determine the characteristics of your negative: density, rendering of light and shadow, and contrast can largely depend on the chosen development time and type, the dilution and the chosen agitation method.

Once your chosen chemical is diluted, bring the solution to the indicated process temperature and pour into the tank. In case you choose to proceed with intermittent agitation it is very important to continuously stir at least for the first 45 seconds. At the end of your chosen development time, you can pour out the solution from the tank.

We suggest to start rotating knob or crank at the same time during the pouring operation.

Temperature: if your current room temperature is much higher or lower than the temperature required by the development, you can make a 2-minutes pre-bath with a water solution brought to a higher temperature (in case room temperature is lower) or less (in case room temperature is higher) of 1-2 ° with respect to the development temperature required subsequently.

STOPPING

The stopping bath must be carried out immediately after the developing one. Although it is also possible to use a simple water solution, we recommend using a dedicated chemical solution (in particular an odourless citric-acid based one). The stopping bath lasts about 45-60" and we recommend to continuously agitate at least for the first 30 seconds.

It is important that the temperature of the water or the stopping solution is as close as possible to the temperature of the developer. Major stress and temperature changes can ruin the film.

FIXING

The fixing bath is the last step of the process before opening the lid. Follow the time and dilution indications of your chosen chemical. Usually the fixing time can last from 5 to 10 minutes depending on the product and the freshness of the solution. If when opening the lid the film looks still very purple, prolong the fixing bath by a few minutes. It is important that the temperature of the fixing solution is as close as possible to the developer and stop temperature. Major stress and temperature changes can ruin the film.

AGITATION

Lab-Box can be used with two types of agitation: continuous and intermittent. Agitation happens by rotating the knob or the crank and exclusively clockwise, as shown by the arrows.

Continuous agitation – 300ml chemical

This is the recommended method to obtain the best results with regards to homogeneity and contrast. Agitation must be continuous by rotating the knob or crank over the entire process. A procedure as possibly irregular and with alternated speed changes is recommended. Moreover, in order to optimise the process further, one could horizontally tilt the tank every 30 seconds to allow for a slight lateral agitation. Continuous agitation is particularly important and recommended over the developing phase.

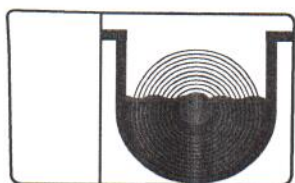

300ml - Half filled
Continuous agitation

Intermittent agitation – 490ml chemical

This mode allows the film to be stirred intermittently. Compared to normal tanks, Lab-Box still needs more frequent agitation. It is therefore advisable to continuously agitate for the first 45 seconds and then for 10 seconds every 30 seconds. The agitation must be as vigorous and fast as possible, 3 half turns of knob every 2 seconds approximately. It is recommended never to exceed 490-500ml of chemistry, otherwise excess liquid could leak out of the tank. Since the tank is full, it is recommended not to move it during the process, in order to avoid leakage of liquid.

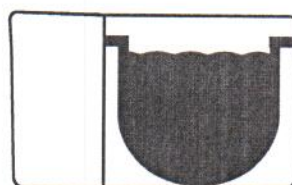

490ml - Full filled
Intermittent agitation

37



VIDEO – 9

WASHING

After fixing it is important to wash the film. Washing is possible both inside and outside the tank.

Washing inside

After having disconnected the module, fill and empty the tank a few times. Then fill the tank approximately halfway and rotate vigorously the knob for about 20-30 seconds. Repeat the process about 10 times and alternate with rinses under running water.

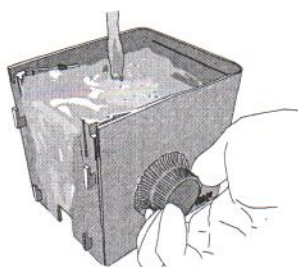

Washing outside

After removing the knob, the reel holding the film can be removed from the tank and placed in a container (a carafe or a jar) to be washed under running water for at least 15 minutes, changing the container water often.

WETTING AGENT

The wetting solution is the last step of the development process before drying the film. It is a very important step as it improves the final cleaning of the film, avoiding that limestone stains remain on the negative. Depending on the dilution and the indications recommended by the chosen product, immerse the film in the solution and make a slight agitation being careful to avoid the formation of too much foam.

We suggest to do it outside the tank in a separate container, just before hanging and drying the film. If you want to do it inside the tank just after the washing, remember to clean and rinse it very well afterwards. After the wetting bath do not rinse the film but manually shake the reel to remove excess liquid.

How to remove the reel from the tank:

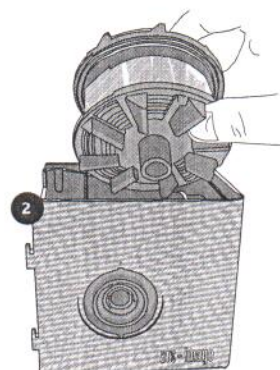

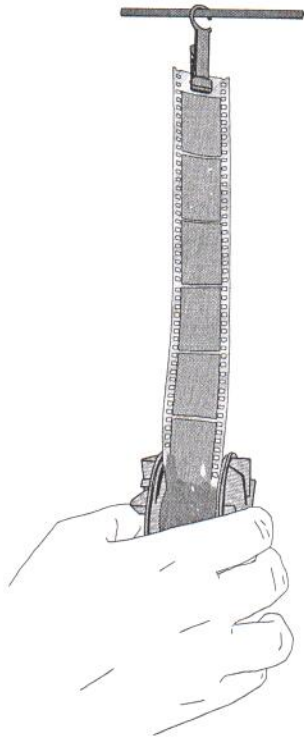

DRYING THE FILM

Using a clip, hook the first piece of film on top of the reel. Once the film is hooked and the clip hanging, you can gently unroll the tank by rotating the reel in the opposite direction. When you have reached the end, you can release the film from or leave the clip with the reel as a weight to keep the film flat. We recommend removing the excess liquid remaining on the film by gently sliding the negative between the index and the middle finger, from top to bottom along its entire length. At this point, it is important not to get close to the film and avoid air drafts, otherwise the dust may get attached to the emulsion, which at this time, still wet, is very delicate.

CLEANING AND DRYING LAB-BOX PARTS

At the end of the process it is very important to thoroughly wash all parts of the tank and then let them dry in the air. If the modules have not caught chemical splashes or drops, you can simply clean them using a damp cloth. In case you need to wash the modules, be careful to remove all the residual water inside and check very thoroughly that all parts are dry. The tank and all its components must be dried carefully. If the next film is to be developed immediately after, special attention must be paid to the grooves of the spiral reel. If an electric dryer is used, only cold air may be employed because of the plastic material.

Trouble shooting



PROBLEM	CAUSES	SOLUTIONS
Loading 35mm film The film was wrongly wound into the reel and/or is stuck or ruined	Incorrectly-assembled reels ----- Incorrectly-positioned Film Guide ----- Incorrectly-clipped film	Make sure that the reels were correctly assembled, in correct position, and aligned ----- Check the position of the film guide for 35mm as mentioned in the checklist ----- Clip the film perfectly in the center
The film does not lock at the end and, even pushing the lever, it won't get cut	The film was not slidden under the two metal pipes ----- Pet Film Base ----- Damaged blade	Open the tank in the dark or inside a changing bag and manually cut the film ----- Pet base films sometimes are very hard to cut: try to firmly push the blade more times and simultanesly pull the film rotating the knob. If it doesn't work, cut the film manually inside a changing bag and then check if the blade is defected. ----- Check the blade and call assistance
The film releases from the clip as soon as I try to load it.	The film was not clipped by sufficiently pressing the clip.	Press the clip between the thumb and forefinger until you hear a "click".

PROBLEM

Loading 120 film

The film is incorrectly loaded in the spiral and / or jammed and ruined

CAUSES

Incorrectly-assembled reels

Incorrectly-positioned Film Guide

Incorrectly-clipped film

SOLUTIONS

Make sure that the reels were correctly assembled, in correct position, and aligned

Check the position of the film guide for 35mm as mentioned in the checklist

Clip the film perfectly in the center

The film got stuck while the black backing paper was being pulled away and did not wrap properly in the inner slot.

Film Chamber left in closed position

Film left in camera for several days and left unrested

Film with PET support

Make sure the film chamber is in the open position (triangle).

Films which are in the camera for more than one week lose their curling quality. To film this quality which is necessary for threading, the film must be rolled up tightly for at least one day.

120 films with PET support cannot be used with Lab-Box.

After clipping the film and opening the film chamber, the film gets stuck and the knob does not rotate.

Clip accidentally stuck with the 120 block spring.

Close and slowly open the 120 Film chamber while at the same time turning the knob until it unlocks. Then reopen the film chamber completely (triangle)

The film releases from the clip as soon as I try to load it.

The film was not clipped by sufficiently pressing the clip.

Press the clip between the thumb and forefinger until you hear a "click".

43

PROBLEM

Developing 135 Film

Film borders are white and undeveloped or unfixed

CAUSES

Film borders touching the reel

SOLUTIONS

It does not cause any problems and does not affect the results.

Scratched film

Blade tip edging out

Make sure the blade is not visible before loading the film, if so push the lever on the back of the module downwards

Dust or residues on the roll gasket

Clean the roll externally

Unevenness in developing, dark spots and side halos

Little or scarce agitation

Stir for longer and more vigorously

Ineffective intermittent agitation

Perform development with continuous agitation and half-filled tank

Chemicals leaking from the sides and/or from the back of tank

Tank filled with more than 490-500ml

Do not fill the tank with more than 490ml

Tank tipped and moved during the process

During the process, keep the tank steady on a flat surface

PROBLEM	CAUSES	SOLUTIONS
Developing 120 Film		
First frame partially burned	First chunk of film gets light when opening the lid to hook the clip	When loading the roll into the machine, advance the film a few centimetres from the standard position before closing the back
Unevenness in developing, dark spots and side halos	Little or scarce agitation	Stir for longer and more vigorously
	Ineffective Intermittent agitation	Perform development with continuous agitation and half-filled tank
Chemicals leaking from the sides and/or from the back of tank	Tank filled with more than 490-500ml	Do not fill the tank with more than 490ml
	Tank tipped and moved during the process	During the process, keep the tank steady on a flat surface

45

Safety information

Keep small children and infants away from device to avoid them being injured by the device's moving parts.

14+ *This is not a toy*

Care and Warranty

Your Lab-Box has two -year warranty against any manufacturer defects. In the event of defect, the ars-imago will repair or replace the item at our discretion. For the warranty service, please contact support@lab-box.it

Technical Specifications

Dimensions: 182x98x124mm (without knob)
Weight: 750g

Materials

ABS and NYLON plastics. FKN and Silicone rubber.
Stainless Steel (135 & 120 Modules)



Designed in Italy. Made in P.R.C.

Customer support

Lab-Box Support Team is always more than happy to hear from you. Get in touch using the contact details provided.

support@lab-box.it
www.lab-box.it

LAB-BOX a project by **ars-imago**



47

LAB-BOX

ars-imago

www.lab-box.it